

allen

Hover Mowers & Hovertrim

OWNER'S HANDBOOK

MODELS:

446 Hovertrim

450 Professional

453 Professional



Main Features

1. Spark Plug/Lead.
2. Exhaust Guard.
3. Engine Cover.
4. Serial No.Label.
5. Engine Start-Grip.
6. Handlebar Securing Knob.
7. Throttle Control.
8. Engine Stop Lever.
9. Handlebar.
10. Fuel Cap.
11. Oil Dipstick.
12. Fuel On/Off Tap.
13. Air Cleaner.

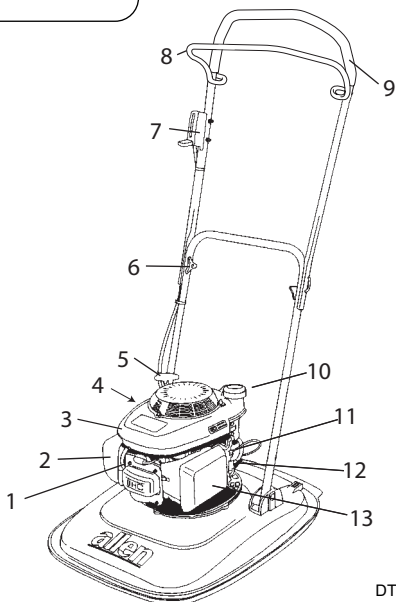

DTP-000-010-A

Specifications

Code	180	181	182
Model	446	450	453
Engine	Honda	Honda	Honda
Engine type	GCV135	GCV160	GCV160
Fuel type	Unleaded petrol	Unleaded petrol	Unleaded petrol
Fuel capacity	0.9 litres	1.1 litres	1.1 litres
Engine Oil type	SAE 10W-30	SAE 10W-30	SAE 10W-30
Oil sump capacity	.55 litres	.55 litres	.55 litres
Cutting width	46 cm (18")	51cm (20")	53cm (21")
Dry Weight	17.6kg	19kg	19kg

1.3	Main Features/Specifications
1.5	Contents
1.6	Introduction
1.7	Warranty
1.8 - 1.11	Safety Precautions
1.8	- Training
1.8 - 1.9	- Preparation
1.9 - 1.10	- Operation
1.10 - 1.11	- Maintenance and Storage
1.11	- Safety Symbols
1.11	- Decal Symbols
1.12	Assembling the Mower
1.12	- Delivery Checklist
1.12	- Assembling
1.13	Before Starting the Mower
1.13	- Prevent Engine Damage
1.13	- Oil Type
1.13	- Check Oil Level
1.13	- Fuel Type
1.14 - 1.19	Operating The Mower
1.14	- Controls
1.14	- Starting
1.15	- Cutting Grass
1.15	- Stopping
1.16	- Adjusting the Cutting Height
1.16	- Before Mowing
1.17 - 1.21	Mower Maintenance
1.17	- Engine
1.17	- Carburettor Adjustments
1.17	- Air Cleaner Service
1.18	- Spark Plug Service
1.18	- Keeping Engine Clean
1.19	- Deck Housing
1.19	- Securing Nuts and Bolts
1.19	- Oil Service
1.20	- Cutterbar Removal
1.20	- Flexiblade Replacement
1.21	- Storage

1.22 - 1.23 Trouble Shooting

1.24 - 1.27 Parts List

1.24	- Mainframe Parts List
1.25	- Exploded View - Mainframe
1.26	- Blade Options / Kits Parts List
1.27	- Exploded View - Blade Options / Kits
1.28	- Kit Options Parts List
1.29	- Exploded View - Kit Options

1.30 Notes

1.31 Customer Info

INTRODUCTION

Thank you for purchasing an **Allen** machine. The following pages are designed to help you gain safe and efficient service from your machine.

IMPORTANT: This 'Owners Handbook' should be regarded as part of the mower as it gives essential information regarding mower safety, operation, maintenance and specifications. Read and understand this handbook prior to operating your machine for the first time. Make sure you are familiar with all the controls and points of regular maintenance. If you have any doubts, consult your local authorised dealer who will be pleased to give you assistance.

IMPORTANT: This machine is designed solely for cutting grass and other low lying ground vegetation within the limitations stated in this manual. Use in any other way is considered as contrary to the intended use. Compliance with and strict adherence to the conditions of operation, service and repair as specified in this handbook also constitute essential elements of the intended use.

This machine should be operated, serviced and repaired only by persons who are familiar with its particular characteristics and who are acquainted with the relevant safety procedures.

The safety precautions listed in this handbook and all other generally recognised regulations on safety must be observed at all times.

Any arbitrary modifications carried out to this machine may relieve the manufacturer of liability for any resulting damage or injury.

Allen machines are robustly constructed and designed for efficient economical performance under normal mowing conditions. Correct operation and maintenance will ensure a long and satisfactory service life. Prior to despatch from our factory every effort is made to ensure that your mower is delivered in perfect condition.

Throughout this handbook all references to **left** and **right** are as viewed from behind the handlebar, in the direction of forward travel.

This handbook is based on information available at the time of publication.

We reserve the right to amend product specifications without prior notification.

LIMITED WARRANTY

The Allen mower business is a subsidiary of Hayter Limited.

The manufacturer warrants to the original user/purchaser that this unit shall be free from defects in material and workmanship under normal use and service for a period of **one year** from the date of purchase. The manufacturers of the engine furnish their own warranty and services are provided through their authorised network (Refer to "Engine Warranty Statement"). To qualify for the full benefit of the warranty, the Warranty Registration Card must be returned within 14 days of purchase. If the selling dealer has not returned the Warranty Registration Card please complete and return. Subject to the conditions and exclusions noted in this limited warranty, we shall at our option, repair or replace any warranted part during the applicable period. If you are in doubt or experience any difficulty, please consult an Authorised Service Dealer for clarification.

A 90 day warranty period applies to those items which are subject to normal wear and tear e.g. wheels, cutterbars, flexiblades, cables and other consumable wearing parts.

This warranty does not apply to any unit that has been tampered with, altered, misused, abused or used for hire, and will become invalid if non genuine parts are fitted. This warranty does not cover for minor mechanical adjustments unless they are due to defective material or workmanship. Consult the Owner's Handbook or an Authorised Service Dealer for assistance when making these adjustments.

To make a warranty claim, return the unit to an Authorised Service Dealer along with proof of purchase stating the machine serial number and date of purchase. Subject to the conditions and exclusions in this limited warranty, the authorised dealer will, at our option, repair or replace any warranted part within the duration of the warranty period.

This limited warranty gives you specific legal rights and is in addition to any statutory rights to which you may be entitled and your statutory rights are not affected by this warranty. If you need additional information concerning this written warranty, or assistance in obtaining services, please write to : **HAYTER LIMITED, Service Department, Spellbrook, Bishop's Stortford, Hertfordshire CM23 4BU**

UK ONLY: Details of your local authorised dealer are contained in Yellow Pages and the Hayter Website www.hayter.co.uk or contact:- Freephone 0800 616298.

SAFETY PRECAUTIONS

Safety Alert Symbol



This safety alert symbol indicates important safety messages. When you see this symbol be alert to the possibility of injury. Carefully read the following and inform others.

Your machine is perfectly safe if used correctly. Failure to observe the following precautions may result in serious injury.

Training



Before using the machine read the owners handbook carefully. Pay particular attention to the safety precautions. Ensure that you are familiar with the controls and the proper use of the equipment. Learn how to stop the machine quickly in an emergency.

Never allow children or people unfamiliar with these instructions to use the machine.

Never operate while people, especially children, or pets are nearby.

Keep in mind that the user is responsible for accidents or hazards occurring to other people or their property.

Preparation



While using the machine, always wear substantial footwear and long trousers. Do not operate the equipment when barefoot or wearing sandals.

Thoroughly inspect the area where the machine is to be used and remove all objects which may be thrown by the machine.

WARNING: Petrol is highly flammable.

- Store fuel in containers specifically designed for this purpose.
- Before starting the engine add fuel outdoors only. Never remove the cap from the fuel tank or add petrol while the engine is running or when the engine is hot. Allow the engine to cool for at least two minutes before refuelling. Do not smoke while refueling.
- Do not attempt to start the engine if petrol is spilled or a smell of petrol is present. Move the machine away from the area of spillage and avoid creating any source of ignition until petrol vapours have dissipated.
- Replace faulty silencers.

Preparation

- Always use fresh fuel. Stale fuel can block the carburettor and cause leakage.
- Replace fuel tank and oil tank caps securely.

A damaged cutter device or impeller or both must be replaced. Before use, always visually inspect the cutting mechanism to ensure that it is in good condition. Do not operate the machine with an out of balance cutting device or impeller.

- Check all nuts and bolts and tighten when necessary.



Operation

Do not operate the engine in a confined space where exhaust fumes (carbon monoxide) can collect. Refuel outdoors only and do not smoke while refuelling.

Always pull the starter cord slowly until resistance is felt. Then pull the cord rapidly to avoid kickback and prevent hand or arm injury.

Operate only in daylight or good artificial light.

Avoid using the machine on wet grass, where feasible.

Always be sure of your footing on slopes.

Walk, never run.

Operate across the face of slopes, never up and down.

Exercise extreme caution when changing direction on slopes.

Do not use on excessively steep slopes.

Use extreme caution when pulling the machine towards you.

Stop the engine before moving the machine across areas other than grass.

Do not change the engine governor settings or overspeed the engine.

Start the engine carefully, with feet well away from the cutting device.



Operation

Do not put hands or feet near or under rotating parts.

Never pick up or carry the machine while the engine is running.

Never touch the exhaust/exhaust guard or cooling fins when the engine is hot.

Stop the engine and disconnect the spark plug lead:

- Before clearing blockages.
- Before cleaning/checking or working on the machine.
- After striking a foreign object. Inspect the machine for damage and ensure necessary repairs are made before re-starting.
- If the machine starts to vibrate abnormally (check immediately). (An out of balance cutting device causes severe vibration).

Stop the engine:

- Whenever you leave the machine.
- Before refuelling.

Maintenance & Storage

Keep all nuts, bolts and screws tight to ensure that the equipment is in safe operating condition.

Frequently check fuel lines and fittings for cracks or leaks and replace if necessary.

Never check for a spark when the spark plug is removed. (Use approved tester)

Inspect the exhaust periodically and replace if worn or leaking.

Never crank the engine with the spark plug removed.

Never start the engine with the air-cleaner or air-cleaner cover removed.

Never store the machine with petrol in the tank within an enclosed area where fumes may reach an open flame or spark.

Allow the engine to cool before storing in any enclosure. To reduce the fire hazard, keep the engine and the surrounding deck area free of grass, leaves, or excessive grease.

SAFETY PRECAUTIONS

Maintenance & Storage

If the fuel tank has to be drained, this should be done outdoors and when the engine is cool.

Wear strong work gloves when removing and reassembling the cutting device.

Always replace worn or faulty parts with genuine Allen parts.



Safety Symbols

Safety Alert - Be aware to the possibility of injury.



Danger of severing toes or fingers in cutting mechanism.



Danger of being hit by thrown objects.



Carefully read the Owners Handbook before using the machine.



Stop engine and remove spark plug lead before working on the mower.

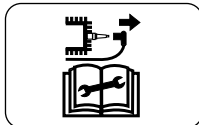

Keep bystanders at a safe distance from the mower.

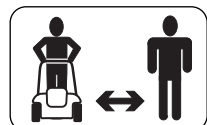

Hearing protection should be worn.



Protective footwear should be worn.



Information Symbols

Engine Stop

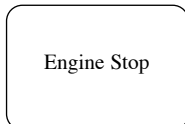

Throttle Control



ASSEMBLING THE MOWER

Delivery Checklist

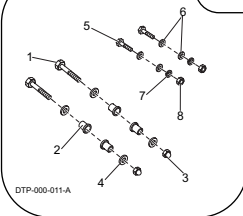

Remove the machine from the packaging and check that the following items have been supplied correctly. If any items are missing contact your local dealer. Main deck, lower and upper handlebars.

- | | | |
|-----------------------|----------------------|--------------------|
| 1. Handlebar bolt x 2 | 5. Throttle bolt x 2 | 9. Spanner x 1* |
| 2. Bush x 4 | 6. Washer x 4 | 10. Ties x 2* |
| 3. Nut x 2 | 7. Spring washer x 2 | 11. Ties* |
| 4. Washer x 4 | 8. Nut x 2 | 12. U Bolt x 2* |
| | | 13. Handwheel x 2* |

*Items 9 - 13 Not Illustrated

Assembling

Step 1 Lower Handlebar

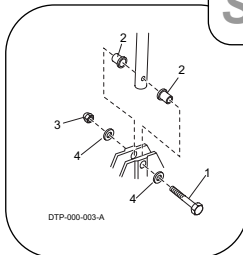

Fit the lower handle first, and position the white bushes (2) as shown on both sides. Place the lower handle between bushes with the kick stop assembly on the right hand side. Attach the lower handle using the fixings supplied.

Step 2 Upper Handlebar

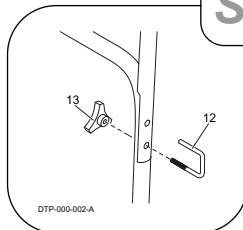

Assemble the upper handle align holes and fit U-bolts and hand/wheel.

Step 3 Throttle Assembly

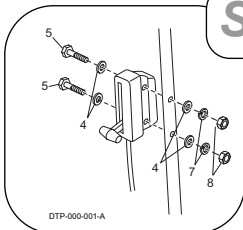

Attach throttle assembly to the outside of the handlebar as shown and secure the cable using ties supplied.

BEFORE STARTING THE MOWER

Prevent Engine Damage

To prevent engine damage the engine is shipped without oil or petrol. The engine must be filled with the correct grade of oil and petrol before starting.



Oil Type

Always use high quality detergent oil classified SAE 10W-30. Never use additives with recommended oil. To prolong the life of your engine it is important that the oil is changed after the first 5 hours of use - refer to 'Maintenance Schedule'.

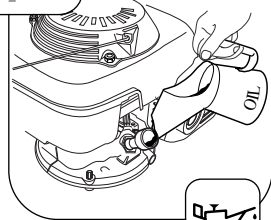

Check Oil Level

Clean around the oil filler cap before removing. With the mower on a level surface, unscrew and remove the oil filler - dipstick. Wipe oil from it with a clean cloth. Screw the oil filler - dipstick back in place, then unscrew and remove it to check the oil level.

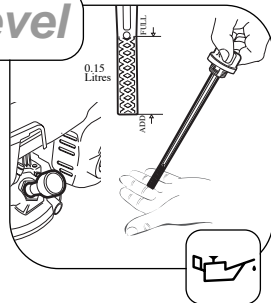

The oil level is correct when it is at the **full** mark on the dipstick.
DO NOT OVERFILL.

Fuel Type

Always use clean, fresh unleaded petrol. Purchase fuel in quantities that can be used within 30 days. Never mix oil with petrol.

Fill to base of neck to allow for fuel expansion. Do not overfill the fuel tank.

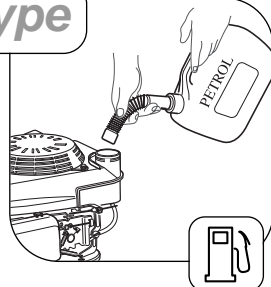

OPERATING THE MOWER

Controls

Check that the engine stop lever moves freely and returns to its rest position when released.

Starting - Step 1

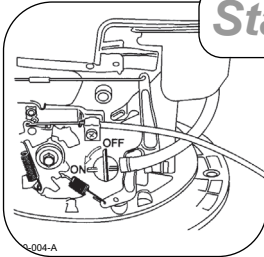

Place the throttle control to the start position, ensure that the fuel tap is in the 'On' position and the tank vent is open (if fitted).

Step 2



Release the handlebar from its parked position. Hold the handlebar together with the engine stop lever, place your foot on the deck and tilt the mower towards you. This will take the load off the engine making it easier to start.

The engine stop lever must be held firmly against the handlebar to start and keep the engine running. If the engine stop lever is released the engine will stop.

Step 3

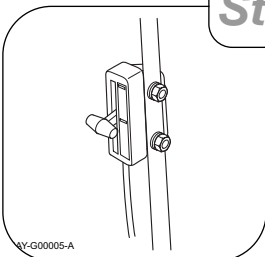

Allow the engine to warm up and move the throttle lever to the 'run' position after starting a cold engine.

To prevent damage never pull the engine start grip when the engine is running.

OPERATING THE MOWER

Cutting Grass

Start at the outside border of the lawn and go round working towards the centre. Always control the mower with both hands, keeping the mower flat on the ground.

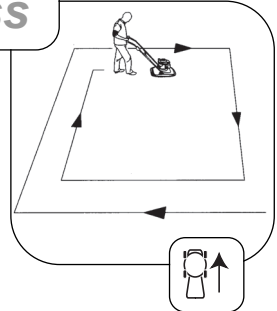

Stopping

Release the engine stop lever.

Emergency stop: Release the engine stop lever.
If the engine fails to stop, disconnect the spark plug lead.

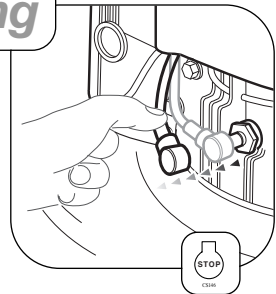

OPERATING THE MOWER

Flexiblade 446

Adjusting the Cutting Height

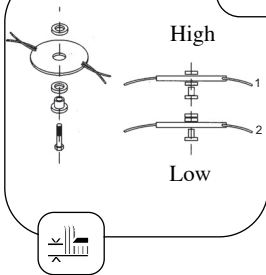

The cutting height of your mower has been set at the highest position (1). If you prefer a lower cut follow these instructions:

- Turn the petrol tap to the off position and where fitted the vent screw.
- Disconnect the spark plug lead.
- Tilt the mower to its side. (Keeping the carburettor uppermost.)
- Remove the retaining bolt with the spanner provided whilst holding the blade or disc. Make sure your hands are adequately protected from the cutting edge.
- Reposition the spacers as required. See diagrams for cutting device option.

Cutterbar 450 / 453

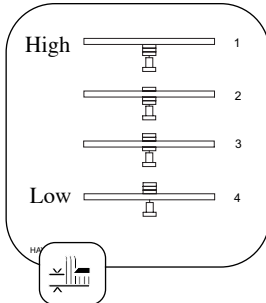

Note for the 446 Hovertrim: One spacer is required above the disc at all times.

NOTE: The large spacer must be positioned directly below the impeller at all times.

TIGHTEN THE BLADE RETAINING BOLT - USE ONLY THE SPANNER PROVIDED.

Before Mowing

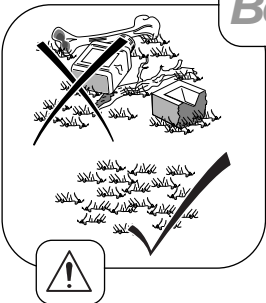

To prevent accidents, thoroughly inspect the area and remove all objects which when contacted by the mower cutterbar could become dangerous projectiles. Inspect the area for hidden obstructions which when contacted by the cutterbar could risk health and safety or result in damage to the mower. Remember the location of these obstructions and ensure that you mow around them.

To prevent accidents stop the engine disconnect the spark plug lead before attempting to carry out maintenance procedures on the mower.



Engine

1. Finger Guard
2. Carburettor
3. Spark Plug / Lead
4. Exhaust Guard
5. Exhaust
6. Oil filler Cap/ Dipstick
7. Start Grip
8. Fuel Cap
9. Air cleaner.

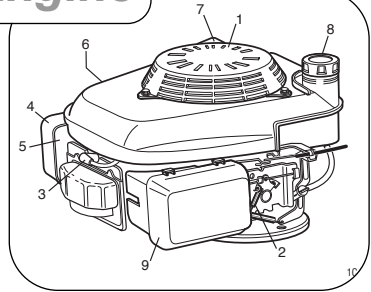

Carburettor Adjustments

Should only be made by an authorised Honda dealer. Under no circumstances should the engine be adjusted to run at a speed in excess of that shown on the Declaration of Conformity.

Air Cleaner Service

To service the air cleaner remove the air cleaner cover (1) by releasing two top catches (2) and tilting away from body until lower tabs release. Remove cartridge (3) and clean by tapping gently on a flat surface. If very dirty or damaged replace.

- Do not brush
- Do not use petroleum solvents.
- Do not oil the cartridge.

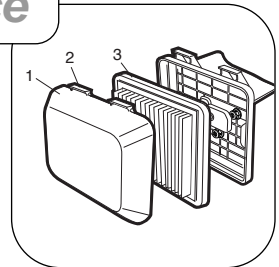

After servicing, install the cartridge in the cover. Insert the tabs on the bottom of the cover into the slots in the bottom of the base. Tilt the cover upwards until the two catches (2) hold it in place.

Spark Plug Service

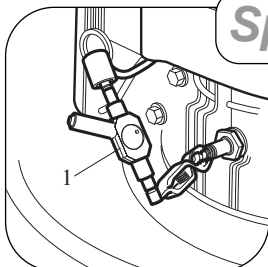

Use only an approved spark tester (1) to check for a spark as shown in the diagram.

Replace the spark plug every 100 hours or every season, whichever occurs first. A spark plug wrench is available from any authorised Honda service dealer.

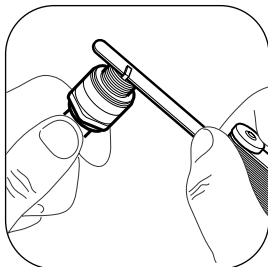

Check the spark plug gap with a feeler gauge and set at 0.7 - 0.8mm.

Keeping Engine Clean

Remove all grass and debris from the engine including the exhaust/exhaust guard, the air ways in the top cowl and the surrounding deck areas on a daily basis after use. Never spray the engine with water during cleaning. Water can contaminate the fuel. Always clean with a brush or compressed air.

Grass and debris may clog the engine's air cooling system especially after prolonged operation while cutting tall, dry grass. The internal cooling fins and surfaces may require cleaning to prevent overheating and engine damage. We recommend that this service be carried out by an authorised dealer.

Deck Housing

Remove grass debris from the top and underside of the deck immediately after use.

Securing Nuts & Bolts

Regularly check that all securing nuts and bolts are tight. Replace missing or damaged items immediately.



Oil Service

Check the oil level daily before starting the engine and ensure that the correct oil level is maintained. Refer to-'Before Starting the Mower' for oil checking and filling instructions.

Change the engine oil after the first 5 hours of operation and thereafter according to the 'Maintenance Schedule':-

1. Drain fuel by running the engine until the fuel tank is empty.
2. Remove the spark plug lead.
3. Allow the engine to cool.
4. Drain the oil while the engine is warm.(Not hot)
5. Tip the machine over on to its side ensuring that the air cleaner is uppermost.
6. Remove the oil filler dipstick and drain the oil into a suitable container.
7. Refill with new oil of the recommended SAE viscosity grade.
(Refer to-'Before Starting the Mower')

Cutterbar Removal

Drain the fuel by running the engine until the fuel tank is empty and the engine stops. **Remove the spark plug lead** and allow the engine to cool. Turn the mower on its left hand side and ensure that the carburettor is uppermost.

Firmly grip the end of the cutterbar with the gloved hand and remove the bolt with the supplied spanner.

To prevent accidents never work on the cutterbar unless the spark plug lead has been removed. The cutterbar has sharp edges. ALWAYS wear strong gloves to protect your hands when working on the cutterbar. DO NOT rotate tools towards the cutting edges to avoid the risk of injury should the tool slip. ALWAYS use genuine replacement parts.

The condition of the cutterbar and its mounting arrangement should be checked regularly for signs of wear or damage. Ensure that the cutterbar is not bent or cracked.

A damaged cutterbar that is out of balance will vibrate excessively and may break. **DO NOT** use an unbalanced cutterbar.

Regularly check that the bolt securing the cutterbar is tightened.

Replace the cutterbar every 2 years or sooner if excessively worn or damaged.

Flexiblade Replacement

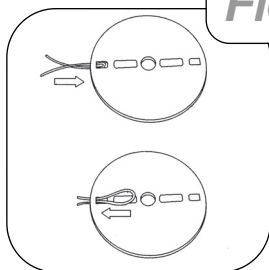

Drain the fuel by running the engine until the fuel tank is empty and the engine stops. **Remove the spark plug lead** and allow the engine to cool. Turn the mower on its left hand side and ensure that the carburettor is uppermost. Wearing protective gloves remove flexiblade and replace with new.

Storage

Engines stored in excess of 30 days need to be protected with a fuel additive or drained of fuel to prevent gum from forming in the fuel system or on essential carburettor parts. To ensure your mower is maintained in good working order it is important that the following procedure is adopted. Refer to the engine handbook as necessary.

Drain fuel from the engine by operating the engine until it stops.

Disconnect the spark plug lead.

Change the engine oil.

Remove the engine spark plug and pour 15ml of engine oil into the engine cylinder and replace the spark plug. Do not exceed the stated volume of oil as engine damage may occur on re-starting. **Do not replace the spark plug lead.** Slowly pull the engine start - grip once to crank the engine. This will distribute the oil and help prevent engine corrosion.

Clean grass and debris from the engine cylinder, cylinder head cooling fins, under top cowl, and around and behind exhaust/exhaust guard.

Lubricate the mower.

Treat metal parts with a water repellent anti-corrosion product.

Cover the mower with a protective sheet and store it in a dry, ventilated area.

PROBLEM	POSSIBLE FAULT	REMEDY
Engine will not turn over	Engine stop lever released. Incorrect oil level. Obstruction under deck.	Operate engine stop lever. Check oil level. Remove obstruction.
Engine smokes	Excess oil level. Air cleaner cartridge oil soaked or blocked.	Check oil level. Service air cleaner.
Engine runs then stops	Fuel starvation. Fuel cap vent blocked. Fuel tap closed.	Fill fuel tank. Clean fuel cap vent. Open fuel tap (if fitted).
Engine will not start	Engine under load. Fuel starvation. Engine cold. Incorrect/contaminated fuel. Spark plug lead disconnected. Throttle setting incorrect. Faulty spark plug.	Raise height of cut. Fill fuel tank. Set throttle to 'choke' position. Drain fuel tank and fill with correct fuel. Connect spark plug lead. Set throttle to 'start' position. Clean and adjust gap or replace.
Engine runs rough	Spark plug lead becoming disconnected in use. Faulty spark plug. Air cleaner blocked. Incorrect/contaminated fuel.	Connect spark plug lead. Clean and adjust gap or replace. Service air cleaner. Drain tank and fill with correct fuel.

PROBLEM	POSSIBLE FAULT	REMEDY
Engine vibrates excessively	Mounting bolts loose.	Tighten bolts
	Cutterbar bolt loose.	Tighten bolt
	Cutterbar out of balance. Bent crankshaft.	Balance cutterbar Consult your dealer
	Damaged impeller or blade	Consult your dealer
Uneven cut	Cutterbar out of balance	Balance the cutterbar
Poor hovering	Engine running slow	Consult your dealer
	Impeller air vents blocked	Check and unblock
	Underdeck not clean	Clean
	Blade loose	Tighten blade

MAINFRAME**PARTS****LIST**

Item No.	Description	Part No.	446	450	453	Item Note
			Qty	Qty	Qty	
1	Upper Handle	H290237	1	1	1	
2	Operator Presence Control	H290239	1	1	1	
3	Grip - Handle Upper	H292276	2	2	2	
4	Kit Cable Securing	H190139	1	1	1	
5	Throttle/Brake Control	H292315	1	1	1	
6	Lower Handle	H290288	1	1	1	
7	M6 U Bolt BZP	H292026	2	2	2	
8	Handwheel M6	H192204	2	2	2	
9	Footstop	H290286	1	1	1	
10	Kit Footstop Securing	H290265	1	1	1	
11	Handlebar/Deck Fix Kit	H290097	2	2	2	
12	Kit Engine Securing	H290267	1	1	1	
13	Kit Engine Mount frame	H290003	1	1	1	
14	Screw	H292279	2	2	2	
15	Upstop Bracket	H292269	1	1	1	
16	Deck 446	H290270	1	0	0	
17	Deck 450/453	H290271	0	1	1	
18	Kit Engine Bolts	H290004	1	1	1	
19	Key Woodruff D16 X 4	H292329	1	1	1	
20	Drive Hub	H290011	1	1	1	
21	Impeller Mk II	H192268	1	1	1	
22	Spanner Petrol	H190210	1	1	1	Not Shown
23	Decal-Warning	H295089	1	1	1	Not Shown
24	Decal 446 Hovertrim Logo	H295125	1	0	0	Not Shown
25	Decal 450 Professional Logo	H295126	0	1	0	Not Shown
26	Logo Allen	H295128	1	1	1	Not Shown
27	Decal A' Logo	H295129	1	1	1	Not Shown
28	Decal Stop	H295159	1	1	1	Not Shown
29	Decal 453 Hover Prof	H295160	0	0	1	Not Shown

MAINFRAME PARTS LIST

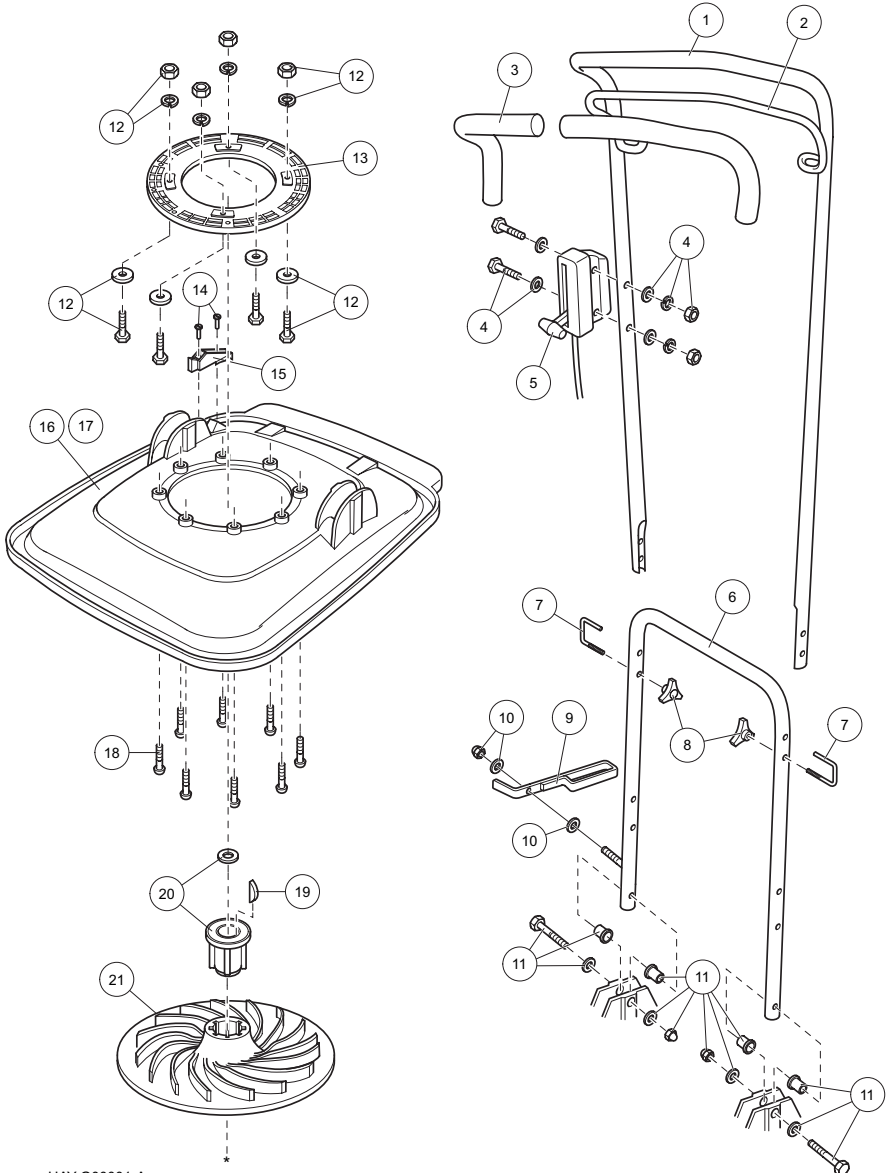

HAY-G00001-A

BLADE**OPTIONS****PARTS****LIST**

Item No.	Description	Part No.	446 Qty	450 Qty	453 Qty	Item Note
1	Spacer	H192270	1	1	1	
2	Spacer Disc	H192025	2	3	3	
3	Blade Ret.Spigot Steel	H192272	1	1	1	
4	Blade/Head Bolt	H292018	1	1	1	
5	Safeway Disc	H292401	1	0	0	
6	Flexiblade 143mtr	H292384	1	0	0	
7	Flexiblade 27mtr	H292385	1	0	0	
8	Blade 20"	H292351	0	1	0	
9	Blade 21"	H192299	0	0	1	

KIT**OPTIONS****Kit - Swinging Blade**

Item No.	Description	Part No.	446 Qty	450 Qty	453 Qty	Item Note
1	Spacer	H192270	1	1	N/A	
2	Spacer Disc	H192025	3	3	N/A	
3	Bottom Plate	H292340	1	0	N/A	
3	Bottom Plate	H292341	0	1	N/A	
4	Swinging Blade (Pack 3)	H292318	1	1	N/A	
5	Swinging Blade (Pack 60)	H292318-60	1	1	N/A	
6	Blade Retaining Kit (Pack 3)	H290276	1	1	N/A	
7	Blade Ret.Spigot Steel	H192272	1	1	N/A	
8	Blade/Head Bolt	H292018	1	1	N/A	

BLADE OPTIONS PARTS LIST

Code 446

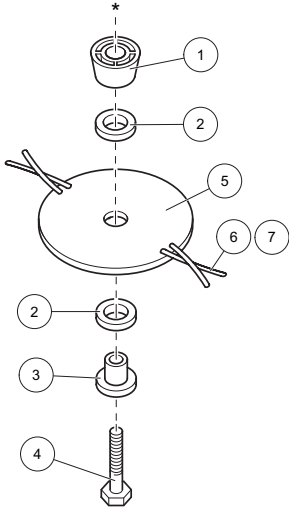

HAY-G00002-A

Code 450/453

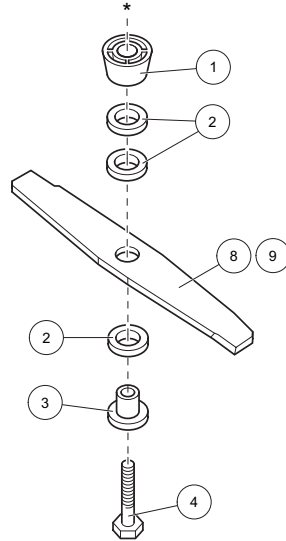

KIT OPTIONS

Kit - Swinging Blade
Code 446/450

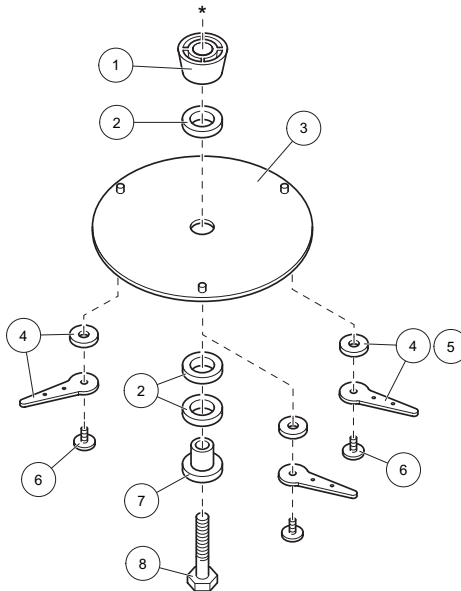

HAY-G00009-A

Kit - Undercarriage (Transport Wheel)

Item No.	Description	Part No.	446	450	453	Item Note
			Qty	Qty	Qty	
1	Undercarriage	H192284	1	1	1	
2	Kit Axle Securing Bolts	H190235	1	1	1	
3	Wheel	H292033	2	2	2	
4	Kit Axle Spacers	H290032	1	1	1	
5	Axle	H192286	1	1	1	
6	Spacer Under Carriage	H192281	2	2	2	
7	Hook Petrol Hover	H192282	2	2	2	
8	Handlebar/Deck Fix Kit	H290097	2	2	2	

Kit - Extension Handles

Item No.	Description	Part No.	446	450	453	Item Note
			Qty	Qty	Qty	
1	Throttle Control & OPC	H292387	1	1	1	Not Shown
2	Handwheel	H192204	2	2	2	Not Shown
3	Handlebar Extension	H292392	1	1	1	Not Shown

KIT OPTIONS PARTS LIST

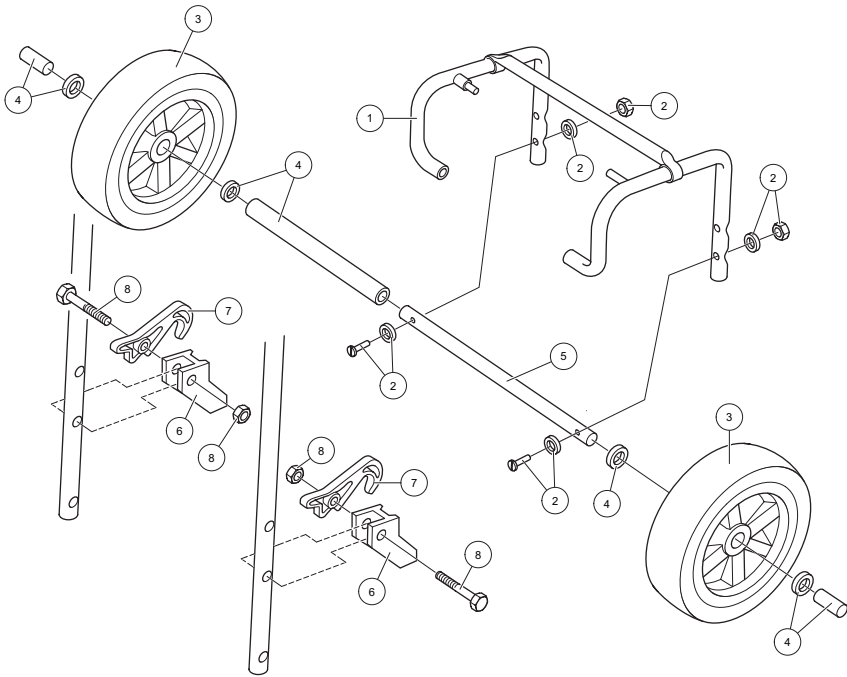

HAY-G00004-A

Notes

CUSTOMER INFORMATION

Serial No:

Engine Type:- GCV135

Engine:- Honda

Engine Type:- GCV160

Engine:- Honda

Date of Sale:- _____

Your Local Dealer:-

DEALER STAMP

Notes:-

YOUR HAYTER DEALER IS:

allen

A subsidiary of Hayter Limited

HAYTER
MAKERS OF THE FINEST MOWERS

Hayter Limited

Spellbrook, Bishop's Stortford, Herts, CM23 4BU, England.

Tel: +44 (0) 1279 723444 Fax: +44 (0) 1279 600338

e-mail: sales@hayter.co.uk

www.hayter.co.uk